

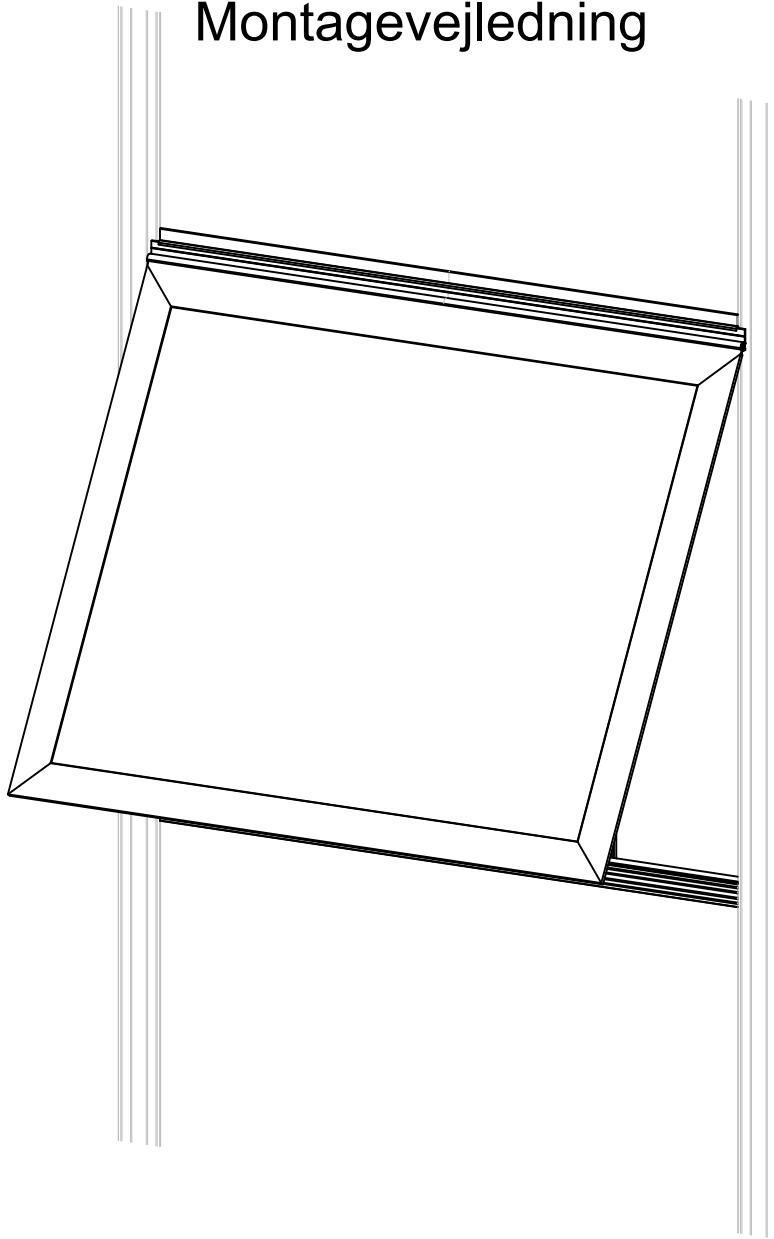



















## Montagevejledning



MODEL: Ekstra vindue til SCANDIC FREJ  
MÅL (BxH): 67.5X61CM  
LÆS HELE VEJLEDNINGEN FØR MONTERING

# LØSDELE OVERSIGT

DEL	NR	STK
	L19A	2
	L19B	1
	L20	1
	L02F	1
	L11	1
	L15A	1
	D49	4
	D46	4
	H43	4
	Y6	1
	Y7	1
	Y10	1
	A01	1
	A03	1
	Z08	22
	M4.2X16	
	Z02	2
	Ø4X16D	
	S26	4
	M5X12	

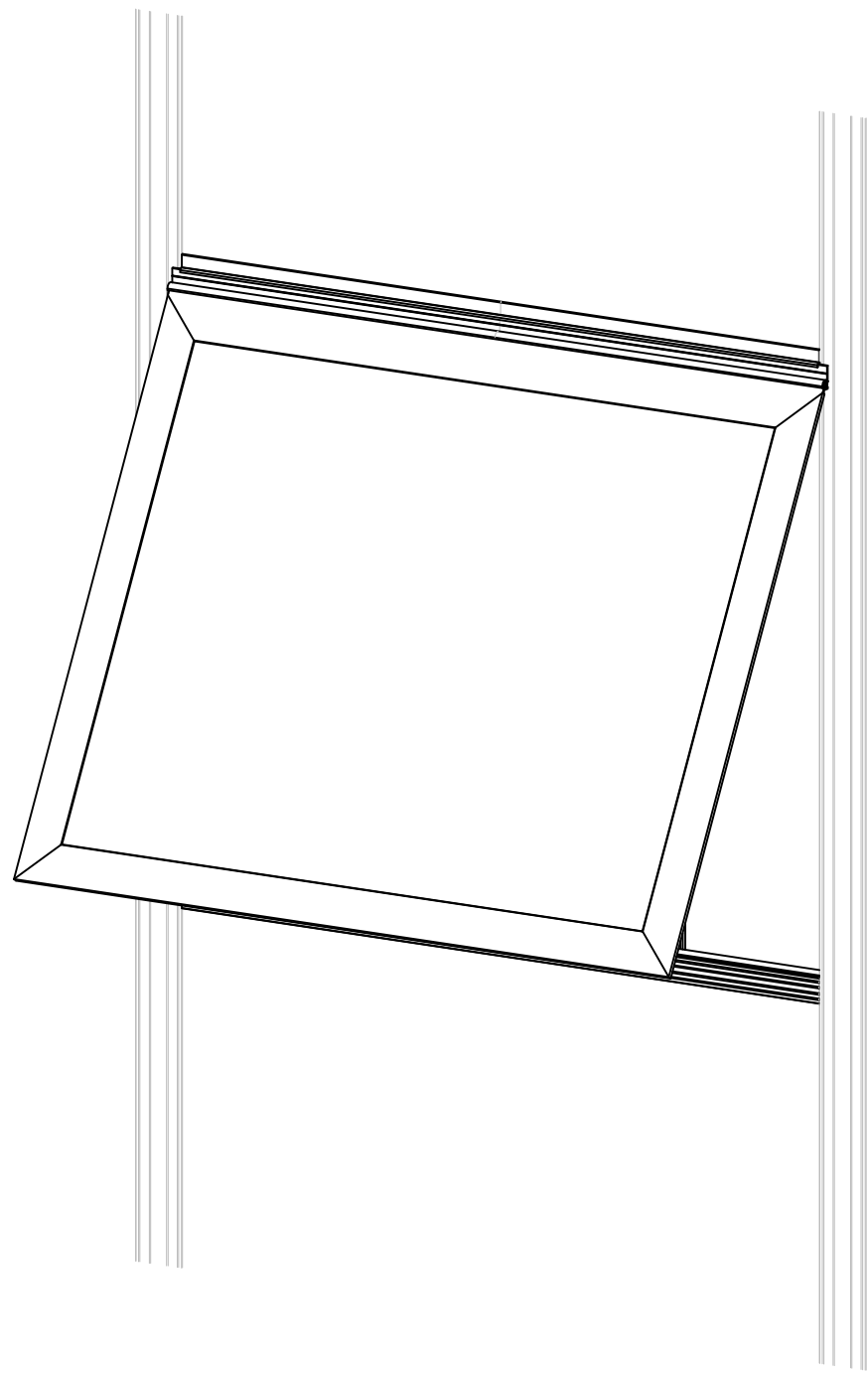

DEL	NR	STK
	L19A	2
	L19B	1
	L20	1
	D46	4
	H43	4
	Z08	10
	M4.2X16	
	Y10	1
	A01	1

# Vindue

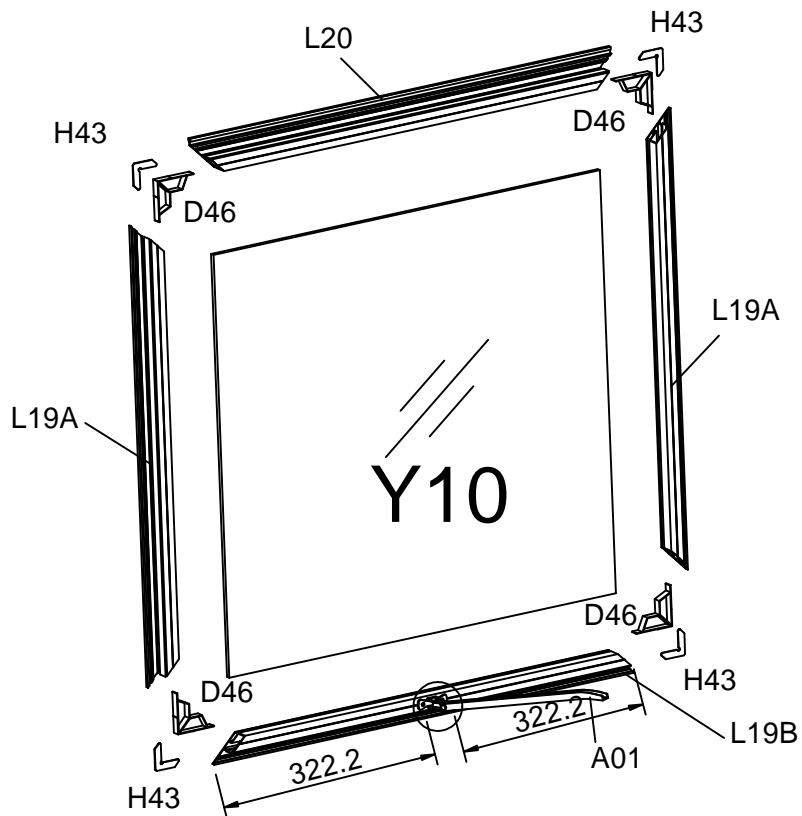

Fastgør A01 midt på L19B, 322.2mm fra hver ende.

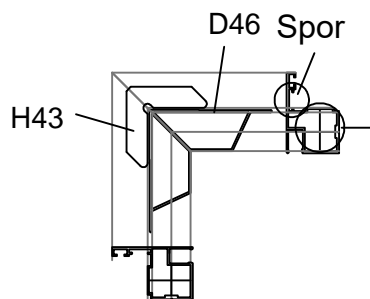
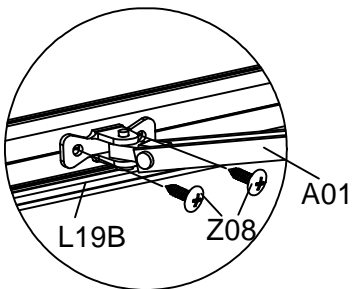

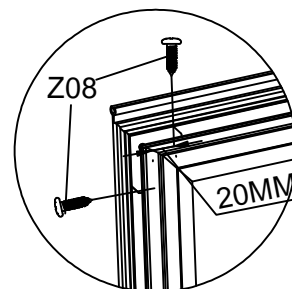
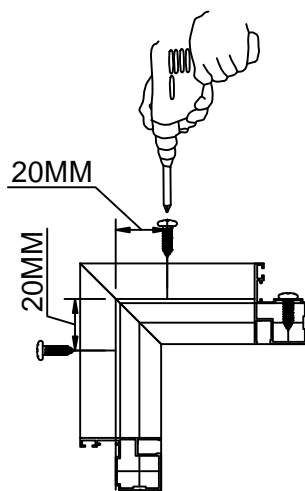

Indsæt H43 i enderne af L19A, L19B & L20. Indsæt samlebeslag D46 ind i L19A, L19B & L20.

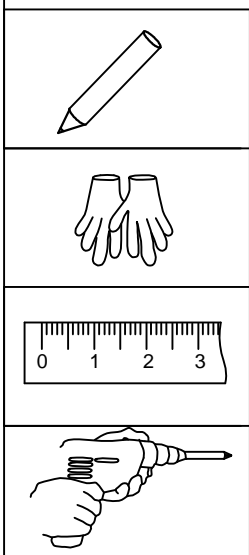

Efter placering af D46 & H43, bruges en skruemaskine til at fastgøre dem med selvskærende skrue Z08, ca. 20mm fra hjørnerne. Vær sikker på at profilerne sidder pænt i smig, inden du skruer dem sammen.







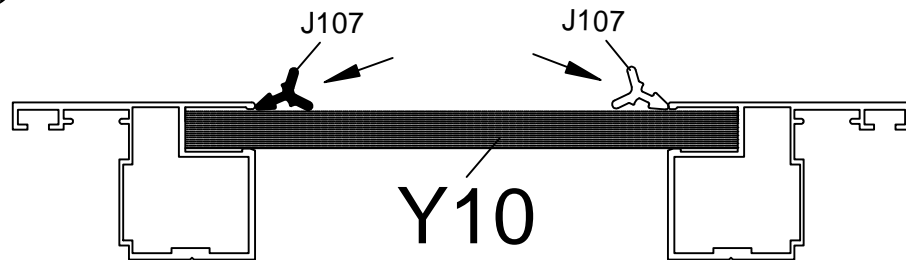
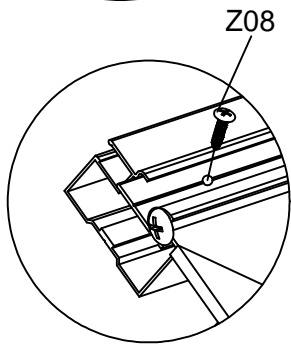
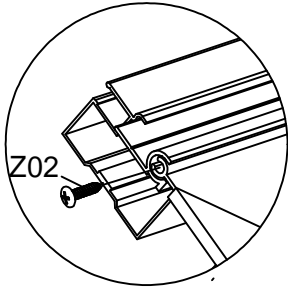
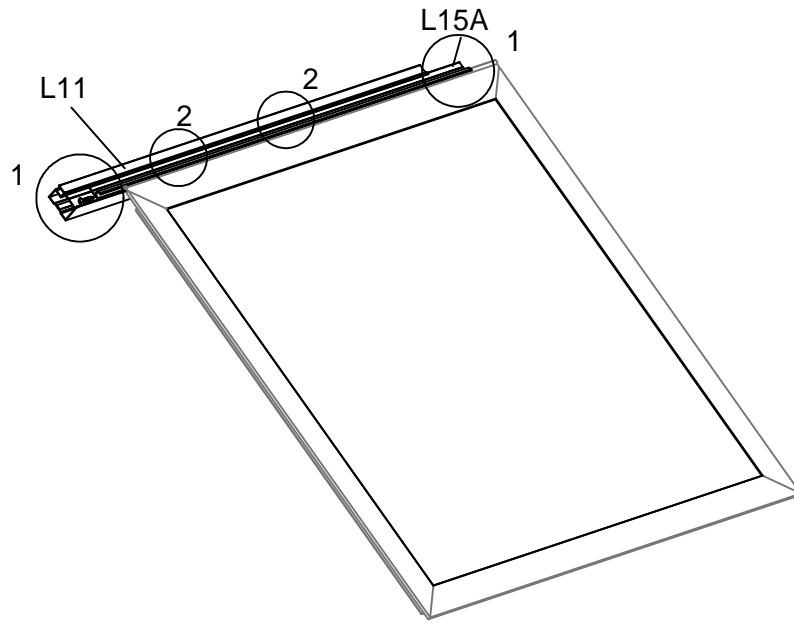

DEL	NR	STK
	L11	1
	L15A	1
	Z08 M4.2X16	2
	Z02 Ø4X16D	2

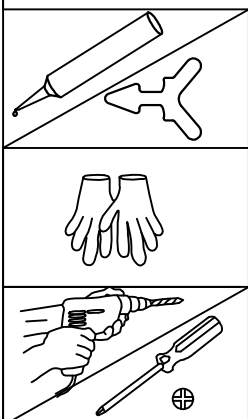
DEL	NR	STK
	J107	2.65M



Hvis du har valgt glas, skal du anvende gummiliste J107. Har du istedet valgt polykarbonat, skal du ikke bruge gummiliste men vi anbefaler istedet at fuldfuge PC pladerne med silikone.



DEL	NR	STK
	L02F	1
	D49	4
	S26 M5X12	4
	Z08 M4.2X16	8
	Y6	1
	Y7	1

I det modul af huset, hvor du ønsker vinduet, skal du fjerne Y5 ruden, denne kommer i overskud. Sænk istedet den nye Y6 på plads.

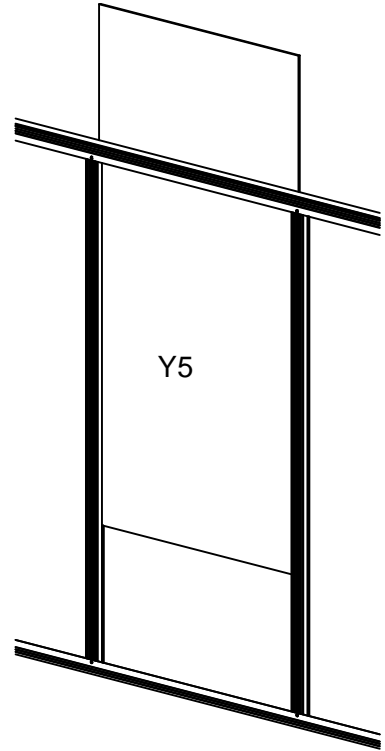

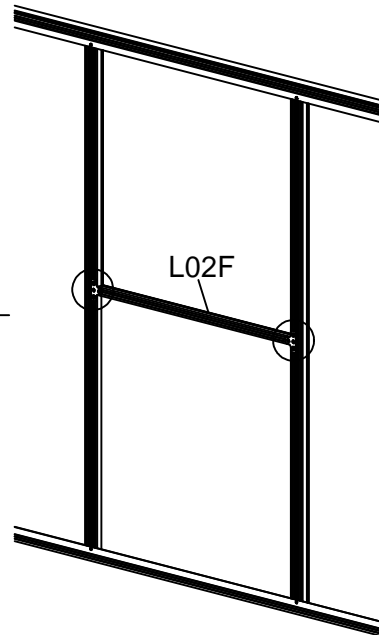
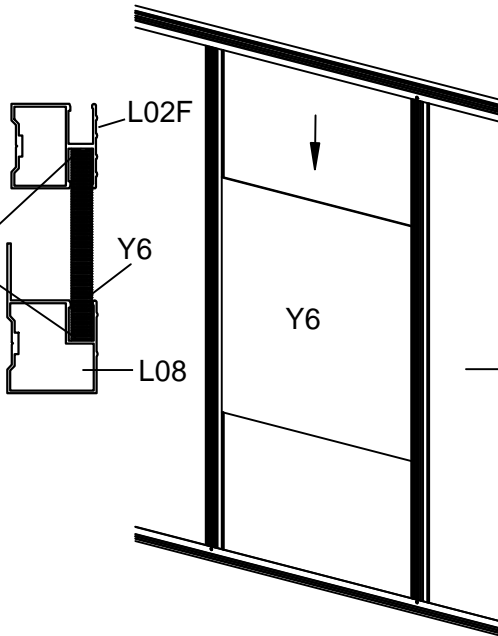

Y6 skal stå ned i bundrammen L08 og L02F monteres ovenpå Y6.

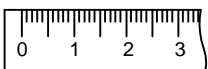
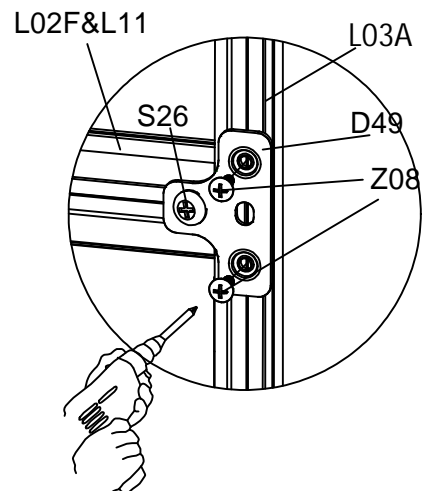

Skrú L02F fast på L03A med beslag D49 med S26 og Z08.



DEL	NR	STK
	A03	1
	Z08 M4.2X16	2

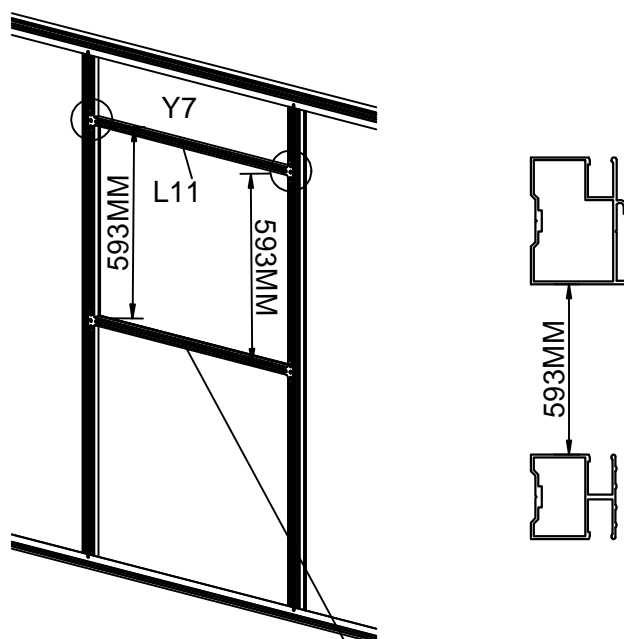

1. Fastgør D49 beslagene på vindues profil L11 med S26
2. Monter vinduet med 10mm luft under ned til L02F.
3. D49 beslaget skrues på L03A med Z08.
4. Sænk Y7 ruden på plads.

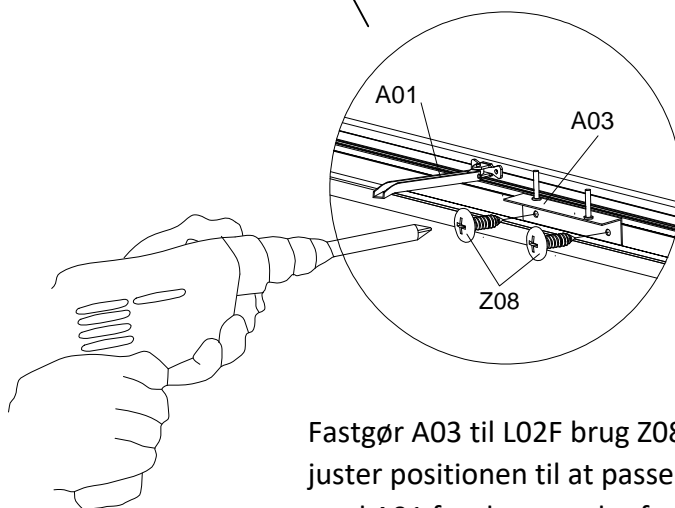

Fastgør A03 til L02F brug Z08, juster positionen til at passe med A01 før du spænder fast.

